







































06 SEW-ON *stones*

Sew-on Stones are loose crystal elements that can be sewn by hand or machine onto any type of textiles or accessories. Sew-on Stones come in two- or three-hole varieties and can be used for a range of decorative purposes or for fine embroidery. Lochrosen are crystals with just one hole.

Sew-on Stones

Summary

<<<

1	2	3		1	2	3	
			3128 3, 4, 5, 6, 7, 8, 10 mm				3257 19x13, 27x19 mm
			3200 10, 12, 14, 16, 18 mm				3265 20x16, 26x21 mm
			3204 8, 10, 12 mm				3270 16, 22 mm
			3210 10x7, 16x11, 24x17 mm				3293 12, 20, 24 mm
			3221 18, 28 mm				3400 6, 8, 10 mm
			3223 12x6, 18x9 mm				3500 9x5.5, 12.5x7, 17x9.5 mm
			3230 12x7, 18x10.5, 28x17 mm				3700 6, 8, 10, 12, 14 mm
			3231 18x11, 23x14, 28x17 mm				
			3240 16, 22 mm				
			3250 18x13, 25x18 mm				
			3254 20x9, 30x14 mm				
			3255 18x6, 26x8.5 mm				
			3256 14x8.5, 19x11.5, 27x16 mm				

1 Top View 2 Side View 3 Back View

Sew-on Stones

3128 XILION Lochrose

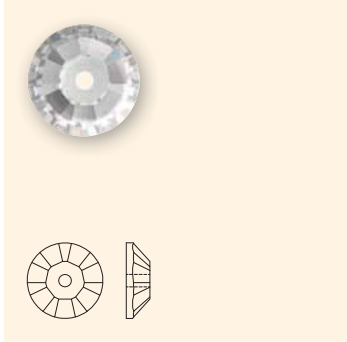







Size	3 mm	4 mm	5 mm	6 mm	7 mm	8 mm	10 mm
------	------	------	------	------	------	------	-------

Colour

Crystal (001)	■	■	■				
Crystal F (001)	■	■	■	■	■	■	■
Crystal AB (001 AB)	■	■	■				
Crystal AB F (001 AB)	■	■	■	■	■	■	■
Crystal Dorado F (001 DOR)	■	■	■				
Crystal Golden Shadow F (001 GSHA)	■	■	■				
Crystal Metallic Light Gold F (001 MLGLD)	■	■	■				
Crystal Moonlight F (001 MOL)	■	■	■				
Crystal Satin F (001 SAT)	■	■	■				
Crystal Silver Shade F (001 SSHA)	■	■	■				
Jet (280)	■	■	■	■	■	■	■
Jet Hematite (280 HEM)	■	■	■				
Jet Nut (280 NUT)	■	■	■				
Air Blue Opal F (285)	■	■	■				
Amethyst F (204)	■	■	■				
Aquamarine F (202)	■	■	■				
Black Diamond F (215)	■	■	■				
Cyclamen Opal F (398)	■	■	■				
Dark Indigo F (288)	■	■	■				
Emerald F (205)	■	■	■				
Fern Green F (291)	■	■	■				
Fuchsia F (502)	■	■	■				
Greige F (284)	■	■	■				
Hyacinth F (236)	■	■	■				
Indian Pink F (289)	■	■	■				
Jonquil F (213)	■	■	■				
Light Amethyst F (212)	■	■	■				
Light Colorado Topaz F (246)	■	■	■				
Light Grey Opal F (383)	■	■	■				
Light Peach F (362)	■	■	■				
Light Rose F (223)	■	■	■				
Light Sapphire F (211)	■	■	■				
Light Siam F (227)	■	■	■				
Light Topaz F (226)	■	■	■				
Mocca F (286)	■	■	■				
Olivine F (228)	■	■	■				
Padparadscha F (542)	■	■	■				
Peridot F (214)	■	■	■				
Provence Lavender F (283)	■	■	■				

Sew-on Stones

Sew-on Stones

3128	Size	3 mm	4 mm	5 mm	6 mm	7 mm	8 mm	10 mm
	Colour							
	 Rose F (209)	■	■	■				
	 Sapphire F (206)	■	■	■				
	 Siam F (208)	■	■	■				
	 Smoked Topaz F (220)	■	■	■				
	 Tanzanite F (539)	■	■	■				
	 Topaz F (203)	■	■	■				

Sew-on Stones

3200 Rivoli Sew-on Stone

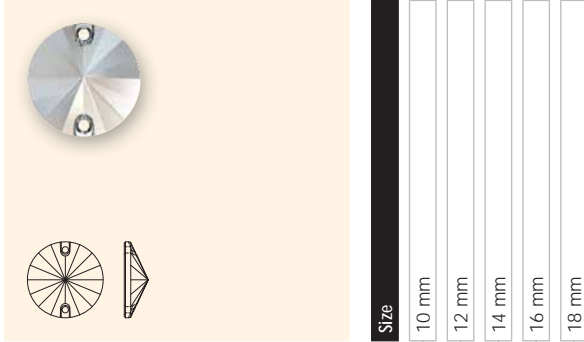

Colour	10 mm	12 mm	14 mm	16 mm	18 mm
Crystal F (001)	■	■	■	■	■
Crystal AB F (001 AB)	■	■	■	■	■
Crystal Dorado F (001 DOR)	■	■	■	■	■
Crystal Golden Shadow F (001 GSHA)	■	■	■	■	■
Crystal Satin F (001 SAT)	■	■	■	■	■
Crystal Silver Shade F (001 SSHA)	■	■	■	■	■
Crystal Tabac F (001 TAB)	■	■	■	■	■
Crystal Volcano F (001 VOL)	■	■	■	■	■
Jet (280)	■	■	■	■	■
Jet Hematite (280 HEM)	■	■	■	■	■
Jet Nut (280 NUT)	■	■	■	■	■
Black Diamond F (215)	■	■	■	■	■
Emerald F (205)	■	■	■	■	■
Erinite F (360)	■	■	■	■	■
Light Amethyst F (212)	■	■	■	■	■
Light Colorado Topaz F (246)	■	■	■	■	■
Light Rose F (223)	■	■	■	■	■
Light Sapphire F (211)	■	■	■	■	■
Light Siam F (227)	■	■	■	■	■
Light Topaz F (226)	■	■	■	■	■
Montana F (207)	■	■	■	■	■
Padparadscha F (542)	■	■	■	■	■
Rose F (209)	■	■	■	■	■
Siam F (208)	■	■	■	■	■
Sun F (248)	■	■	■	■	■
Tanzanite F (539)	■	■	■	■	■

3204 XILION Sew-on Stone

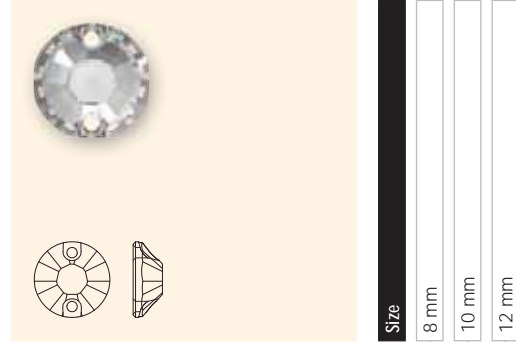

Colour	8 mm	10 mm	12 mm
Crystal F (001)	■	■	■
Crystal AB F (001 AB)	■	■	■
Crystal Golden Shadow F (001 GSHA)	■	■	■
Crystal Satin F (001 SAT)	■	■	■
Jet (280)	■	■	■
Amethyst F (204)	■	■	■
Black Diamond F (215)	■	■	■
Emerald F (205)	■	■	■
Indicolite F (379)	■	■	■
Light Rose F (223)	■	■	■
Light Topaz F (226)	■	■	■
Olivine F (228)	■	■	■
Sapphire F (206)	■	■	■
Siam F (208)	■	■	■
Smoked Topaz F (220)	■	■	■

Sew-on Stones

Sew-on Stones

3210 Oval Sew-on Stone

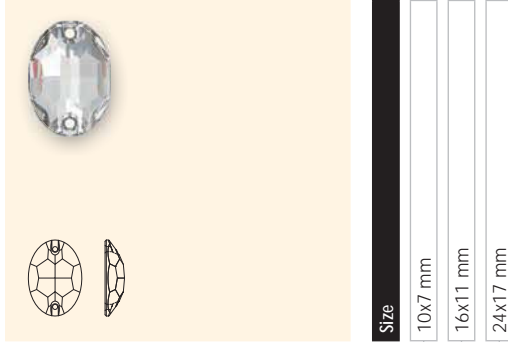

Colour		Size	10x7 mm	16x11 mm	24x17 mm
	Crystal F (001)		■	■	■
	Crystal AB F (001 AB)		■	■	■
	Crystal Copper F (001 COP)		■	■	■
	Crystal Golden Shadow F (001 GSHA)	New!	■	■	■
	Crystal Metallic Light Gold F (001 MLGLD)		■	■	■
	Crystal Satin F (001 SAT)		■	■	■
	Crystal Silver Shade F (001 SSHA)	New!	■	■	■
	Jet (280)		■	■	■
	Jet Hematite (280 HEM)	New!	■	■	■
	Light Amethyst F (212)		■	■	■
	Light Colorado Topaz F (246)		■	■	■
	Light Sapphire F (211)		■	■	■
	Olivine F (228)		■	■	■
	Smoked Topaz F (220)	New!	■	■	■

3221 Twist Sew-on Stone

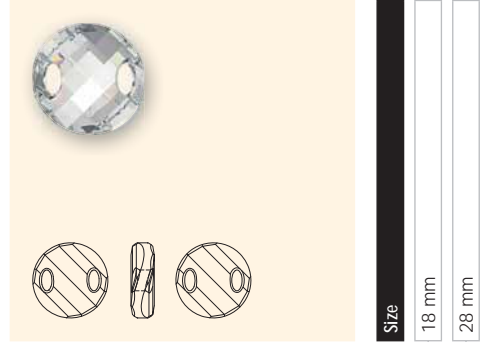

Colour		Size	18 mm	28 mm
	Crystal (001)		■	■
	Crystal F (001)		■	■
	Crystal Copper (001 COP)		■	■
	Crystal Golden Shadow (001 GSHA)		■	■
	Crystal Moonlight (001 MOL)		■	■
	Crystal Red Magma (001 REDM)		■	■
	Crystal Silver Shade (001 SSHA)		■	■
	Jet (280)		■	■
	Aquamarine (202)		■	■
	Black Diamond (215)		■	■
	Mocca (286)		■	■

3223 Navette Sew-on Stone

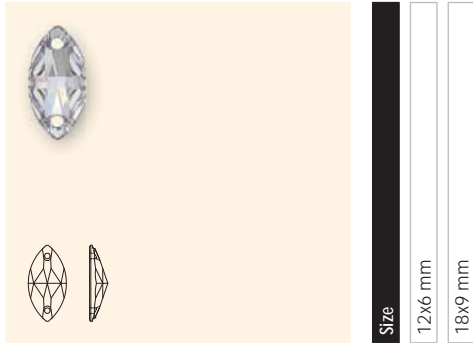

Colour		Size	12x6 mm	18x9 mm
	Crystal F (001)		■	■
	Crystal AB F (001 AB)		■	■
	Crystal Golden Shadow F (001 GSHA)	New!	■	■
	Crystal Metallic Light Gold F (001 MLGLD)		■	■
	Crystal Silver Shade F (001 SSHA)	New!	■	■
	Jet (280)		■	■
	Jet Hematite (280 HEM)	New!	■	■
	Light Amethyst F (212)	New!	■	■
	Light Sapphire F (211)	New!	■	■
	Smoked Topaz F (220)	New!	■	■

Sew-on Stones

3230 Drop Sew-on Stone

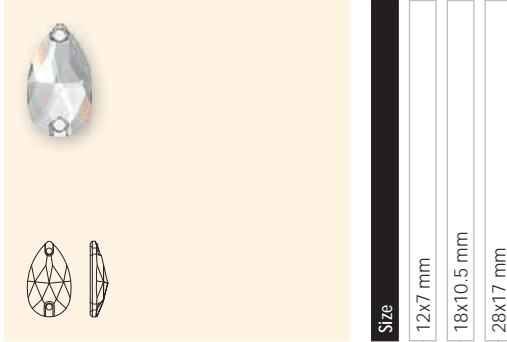

Colour	12x7 mm	18x10.5 mm	28x17 mm
Crystal F (001)	■	■	■
Crystal AB F (001 AB)	■	■	■
Crystal Copper F (001 COP)	■	■	■
Crystal Golden Shadow F (001 GSHA)	■	■	■
Crystal Metallic Light Gold F (001 MLGLD)	■	■	■
Crystal Satin F (001 SAT)	■	■	■
Crystal Silver Shade F (001 SSHA)	■	■	■
Jet (280)	■	■	■
Jet Hematite (280 HEM)	■	■	■
Light Amethyst F (212)	■	■	■
Light Colorado Topaz F (246)	■	■	■
Light Sapphire F (211)	■	■	■
Olivine F (228)	■	■	■
Smoked Topaz F (220)	■	■	■

3231 Owllet Sew-on Stone

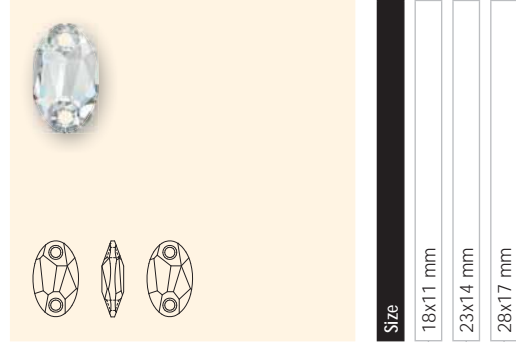

Colour	18x11 mm	23x14 mm	28x17 mm
Crystal (001)	■	■	■
Crystal F (001)	■	■	■
Crystal Copper (001 COP)	■	■	■
Crystal Golden Shadow (001 GSHA)	■	■	■
Crystal Moonlight (001 MOL)	■	■	■
Crystal Red Magma (001 REDM)	■	■	■
Crystal Silver Shade (001 SSHA)	■	■	■
Jet (280)	■	■	■
Aquamarine (202)	■	■	■
Black Diamond (215)	■	■	■
Emerald (205)	■	■	■
Jonquil (213)	■	■	■
Light Rose (223)	■	■	■
Smoked Topaz (220)	■	■	■

3240 Square Sew-on Stone

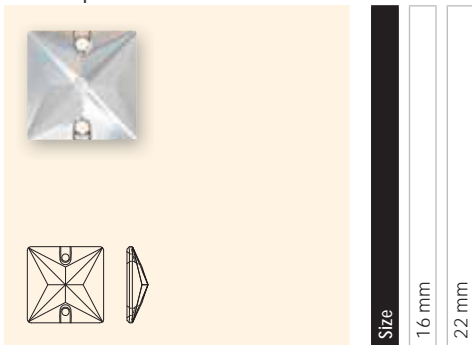

Colour	16 mm	22 mm
Crystal F (001)	■	■
Crystal AB F (001 AB)	■	■
Crystal Dorado F (001 DOR)	■	■
Crystal Sage F (001 SAG)	■	■
Crystal Satin F (001 SAT)	■	■
Crystal Volcano F (001 VOL)	■	■
Jet (280)	■	■
Jet Hematite (280 HEM)	■	■
Jet Nut (280 NUT)	■	■

3250 Rectangle Sew-on Stone

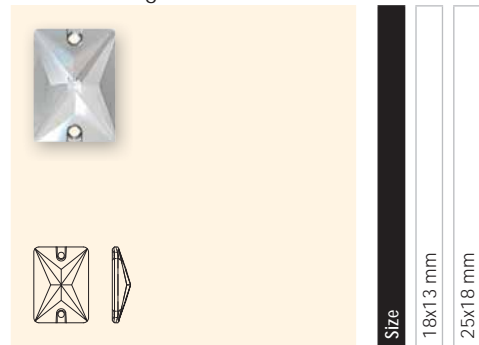

Colour	18x13 mm	25x18 mm
Crystal F (001)	■	■
Crystal AB F (001 AB)	■	■
Crystal Satin F (001 SAT)	■	■
Crystal Tabac F (001 TAB)	■	■
Jet (280)	■	■
Jet Hematite (280 HEM)	■	■
Jet Nut (280 NUT)	■	■

Sew-on Stones

3254 Diamond Leaf Sew-on Stone



Colour		20x9 mm	30x14 mm
Crystal F (001)		■	■
Crystal Copper F (001 COP)		■	■
Crystal Golden Shadow F (001 GSHA)		■	■
Crystal Red Magma F (001 REDM)		■	■
Crystal Silver Shade F (001 SSHA)		■	■
Jet (280)		■	■
Aquamarine F (202)		■	
Light Rose F (223)		■	
Light Topaz F (226)		■	
Mocca F (286)		■	
Olivine F (228)		■	

3255 Cosmic Baguette Sew-on Stone

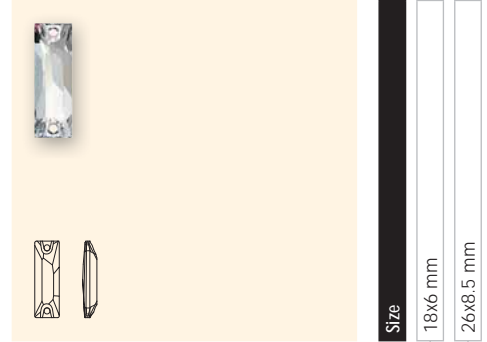

Colour		18x6 mm	26x8.5 mm
Crystal F (001)		■	■
Crystal Copper F (001 COP)		■	■
Crystal Golden Shadow F (001 GSHA)		■	■
Crystal Moonlight F (001 MOL)		■	■
Crystal Red Magma F (001 REDM)		■	■
Crystal Silver Shade F (001 SSHA)		■	■
Crystal Volcano F (001 VOL)		■	■
Jet (280)		■	■
Aquamarine F (202)		■	■
Black Diamond F (215)		■	■
Mocca F (286)		■	■

3256 Galactic Sew-on Stone

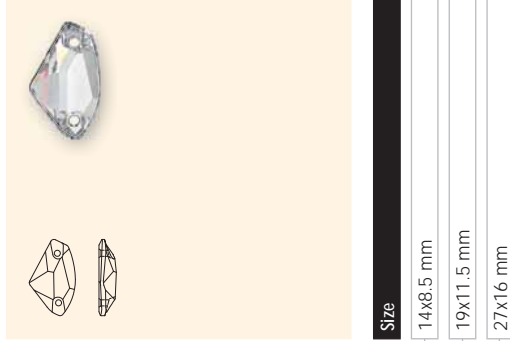

Colour		14x8.5 mm	19x11.5 mm	27x16 mm
Crystal F (001)		■	■	■
Crystal Copper F (001 COP)		■	■	■
Crystal Golden Shadow F (001 GSHA)		■	■	■
Crystal Moonlight F (001 MOL)		■	■	■
Crystal Red Magma F (001 REDM)		■	■	■
Crystal Silver Shade F (001 SSHA)		■	■	■
Jet (280)		■	■	■
Aquamarine F (202)		■	■	
Black Diamond F (215)		■	■	
Mocca F (286)		■	■	

3257 Divine Rock Sew-on Stone



Colour		19x13 mm	27x19 mm
Crystal F (001)		■	■
Crystal Golden Shadow F (001 GSHA)		■	■
Crystal Red Magma F (001 REDM)		■	■
Crystal Silver Shade F (001 SSHA)		■	■
Jet (280)		■	■
Aquamarine F (202)		■	■
Jonquil F (213)		■	■
Light Rose F (223)		■	■
Montana F (207)		■	■
Topaz F (203)		■	■

Sew-on Stones

Sew-on Stones

3265 Cosmic Sew-on Stone*



Size
20x16 mm
26x21 mm

Colour	
Crystal F (001)	■ ■
Crystal AB F (001 AB)	■ ■
Crystal Copper F (001 COP)	■ ■
Crystal Golden Shadow F (001 GSHA)	■ ■
Crystal Red Magma F (001 REDM)	■ ■
Crystal Silver Shade F (001 SSHA)	■ ■
Crystal Volcano F (001 VOL)	■ ■
Jet (280)	■ ■
Aquamarine F (202)	■ ■
Black Diamond F (215)	■ ■
Mocca F (286)	■ ■

3270 Triangle Sew-on Stone

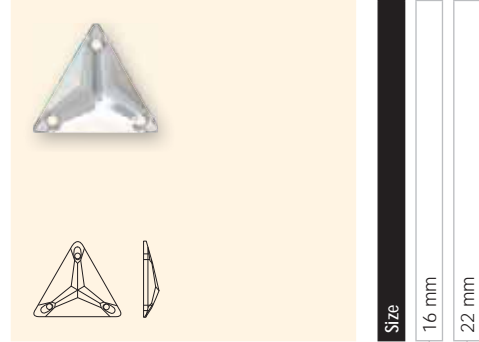

Size
16 mm
22 mm

Colour	
Crystal F (001)	■ ■
Crystal AB F (001 AB)	■ ■
Crystal Dorado F (001 DOR)	■ ■
Crystal Satin F (001 SAT)	■ ■
Crystal Tabac F (001 TAB)	■ ■
Crystal Volcano F (001 VOL)	■ ■
Jet (280)	■ ■
Jet Hematite (280 HEM)	■ ■
Jet Nut (280 NUT)	■ ■

3293 Chessboard Sew-on Stone

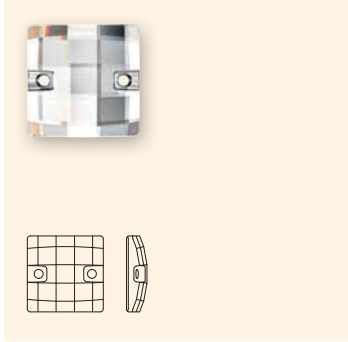

Size
12 mm
20 mm
24 mm

Colour	
Crystal F (001)	■ ■ ■
Jet (280)	■ ■ ■
Jet Hematite (280 HEM)	■ ■ ■
Aquamarine F (202)	■ ■ ■
Light Colorado Topaz F (246)	■ ■ ■
Peridot F (214)	■ ■ ■
Silk F (391)	■ ■ ■
Smoked Topaz F (220)	■ ■ ■

* For art. 3265 Cosmic Sew-on Stone a sew-on aid is available. For further information please refer to the details at the end of this chapter.

Sew-on Stones

3400 Square Lochrose

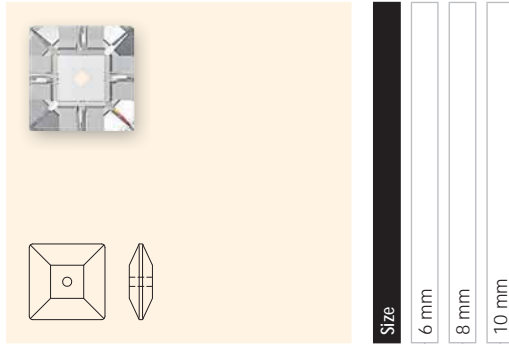

Colour	6 mm	8 mm	10 mm
Crystal F (001)	■	■	■
Crystal AB F (001 AB)	■	■	■
Crystal Metallic Light Gold F (001 MLGLD)	■		
Crystal Sage F (001 SAG)	■		
Crystal Satin F (001 SAT)	■		
Crystal Silver Shade F (001 SSHA) <i>New!</i>	■		
Crystal Tabac F (001 TAB)	■		
Crystal Volcano F (001 VOL)	■		
Jet (280)	■	■	■
Jet Hematite (280 HEM)	■		
Jet Nut (280 NUT)	■		
Emerald F (205) <i>New!</i>	■		
Jonquil F (213) <i>New!</i>	■		
Light Amethyst F (212) <i>New!</i>	■		
Light Colorado Topaz F (246)	■		
Light Rose F (223)	■		
Light Sapphire F (211)	■		
Light Siam F (227)	■		
Rose F (209) <i>New!</i>	■		
Sapphire F (206) <i>New!</i>	■		

3500 Pendular Lochrose

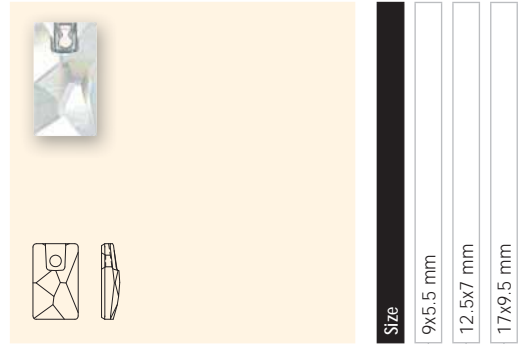

Colour	9x5.5 mm	12.5x7 mm	17x9.5 mm
Crystal F (001)	■	■	■
Crystal AB F (001 AB)	■	■	■
Crystal Golden Shadow F (001 GSHA)	■	■	■
Crystal Red Magma F (001 REDM)	■	■	■
Crystal Silver Shade F (001 SSHA)	■	■	■
Jet (280)	■	■	■
Jet Hematite (280 HEM)	■	■	■
Aquamarine F (202)	■	■	■
Black Diamond F (215)	■	■	■
Jonquil F (213)	■	■	■
Smoked Topaz F (220)	■	■	■
Vintage Rose F (319)	■	■	■

Sew-on Stones

3700 Marguerite Lochrose

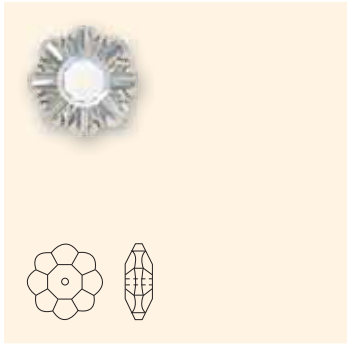

Size	6 mm	8 mm	10 mm	12 mm	14 mm
------	------	------	-------	-------	-------

Colour	6 mm	8 mm	10 mm	12 mm	14 mm
Crystal (001)	■	■	■	■	
Crystal F (001)	■	■	■	■	■
Crystal AB (001 AB)	■	■	■	■	■
Crystal AB F (001 AB)	■	■	■	■	
Crystal Heliotrope (001 HEL)	■	■	■		
Crystal Metallic Light Gold F (001 MLGLD)	■	■	■		
Crystal Satin F (001 SAT)	■	■	■		
Crystal Transmission V (001 TRAV)	■	■	■		
Crystal Vitrail Medium (001 VM)	■	■	■		
Crystal Volcano F (001 VOL)	■	■	■		
Jet (280)	■	■	■	■	■
Amethyst (204)	■	■	■		
Emerald (205)	■	■	■		
Erinite (360)	■	■	■		
Fuchsia (502)	■	■	■		
Jonquil (213)	■	■	■		
Light Amethyst (212)	■	■	■		
Light Colorado Topaz (246)	■	■	■		
Light Peach (362)	■	■	■		
Light Rose (223)	■	■	■		
Light Sapphire (211)	■	■	■		
Light Siam (227)	■	■	■	■	
Peridot (214)	■	■	■	■	
Rose (209)	■	■	■		
Sapphire (206)	■	■	■		
Siam (208)	■	■	■		
Sun (248)	■	■	■		
Tanzanite (539)	■	■	■		
Topaz (203)	■	■	■	■	

Sew-on Stones

* For art. 3265 Cosmic Sew-on Stone a sew-on aid is available. For further information please refer to the details at the end of this chapter.

This sew-on aid perfectly fits art. 3265 Cosmic Sew-on Stone and is most recommended for the application by sewing machine.

9040/060, 9040/061 Sew-on Aid

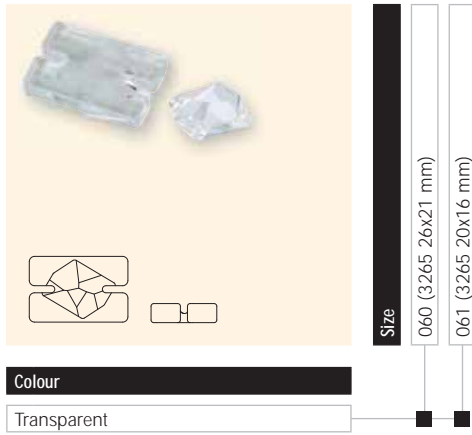

Size	
060 (3265 26x21 mm)	061 (3265 20x16 mm)

Colour	
Transparent	

Article Size	Packing Unit = Minimum Order Quantity in Pieces	Average Net Weight in Gram per Packing Unit Crystal (001)	Average Gross Weight in Gram per Packing Unit Crystal (001)
3128			
3 mm	1,440	15.8	27.2
4 mm	1,440	44.9	56.1
5 mm	720	39.0	50.0
6 mm	360	32.1	43.1
7 mm	144	20.6	31.4
8 mm	144	34.1	45.1
10 mm	72	33.3	44.2
3200			
10 mm	72	26.1	44.6
12 mm	48	36.3	54.8
14 mm	72	77.2	100.7
16 mm	72	115.8	139.4
18 mm	72	147.1	170.8
3204			
8 mm	144	43.9	54.8
10 mm	72	39.4	50.3
12 mm	72	61.0	84.4
3210			
10x7 mm	72	18.1	37.9
16x11 mm	72	66.3	86.3
24x17 mm	24	72.5	97.9
3221			
18 mm	72	174.8	198.5
28 mm	24	210.9	243.7
3223			
12x6 mm	48	13.1	34.2
18x9 mm	36	27.7	45.1
3230			
12x7 mm	96	29.7	47.0
18x10.5 mm	72	70.5	90.7
28x17 mm	24	72.1	97.5
3231			
18x11 mm	96	120.5	148.2
23x14 mm	36	96.4	126.9
28x17 mm	30	153.2	179.4
3240			
16 mm	72	108.5	132.1
22 mm	24	88.0	139.6
3250			
18x13 mm	72	111.5	135.1
25x18 mm	24	84.4	130.7
3254			
20x9 mm	72	60.3	87.8
30x14 mm	36	100.6	129.6
3255			
18x6 mm	96	64.3	87.1
26x8.5 mm	48	87.6	125.6
3256			
14x8.5 mm	96	48.2	67.5
19x11.5 mm	96	104.5	140.1
27x16 mm	30	95.4	128.9

Sew-on Stones

Article Size	Packing Unit = Minimum Order Quantity in Pieces	Average Net Weight in Gram per Packing Unit Crystal (001)	Average Gross Weight in Gram per Packing Unit Crystal (001)
3257			
19x13 mm	96	58.3	76.3
27x19 mm	30	132.2	152.0
3265			
20x16 mm	72	113.5	138.4
26x21 mm	20	59.8	85.0
3270			
16 mm	72	96.4	120.0
22 mm	24	72.3	117.4
3293			
12 mm	72	72.3	95.7
20 mm	30	128.1	160.8
24 mm	24	188.8	218.2
3400			
6 mm	360	47.5	58.4
8 mm	288	81.1	107.2
10 mm	144	72.3	93.4
3500			
9x5.5 mm	144	28.9	38.0
12.5x7 mm	144	69.4	88.3
117x9.5 mm	72	74.3	89.4
3700			
6 mm	720	50.6	61.4
8 mm	288	62.2	88.4
10 mm	288	114.5	141.0
12 mm	144	105.4	128.5
14 mm	144	170.5	197.2
9040/060			
for 3265 26x21 mm	1	-	-
9040/061			
for 3265 20x16 mm	1	-	-

Photography: Christoph Sagel, Robert Striegl
Content is subject to change without notice. Errors and misprints excepted.
SWAROVSKI AG · P.O. Box 567 · 9495 Triesen · Liechtenstein

© 2010 Swarovski AG. All rights reserved. Partial or total publication, transmission, copy or other duplication of texts, graphics, pictures etc. which are to be found in this publication is forbidden without special consent by Swarovski AG.